

## MODE LUX

Lavabo da appoggio circolare, realizzato in ceramica decorata.

*Round countertop washbasin produced in ceramic with decoration.*

**Articolo:** Mode Lux

**Tipologia:** Lavabo sopra piano

**Materiale:** Terra di Siena

**Troppo pieno:** No

**Peso lavabo:** kg ±7,00

**Article:** Mode Lux

**Category:** Countertop washbasin

**Material:** Terra di Siena

**Overflow:** No

**Washbasin weight:** kg ±7,00



### COLORI COLOURS

white mat/silver

MODE40BOSL



white mat/gold

MODE40BOCD



gunmetal/silver

MODE40GMSL



gunmetal/gold

MODE40GMGD



gunmetal/dark inox

MODE40GMDI



gunmetal/bronze

MODE40GMBZ



### DATI TECNICI TECHNICAL DATA

Prodotto artigianale, misure soggette a piccole variazioni.

*Handcrafted product, dimensions subject to small variations.*

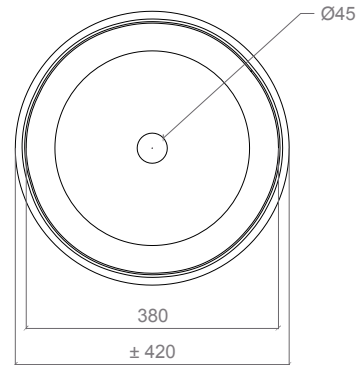
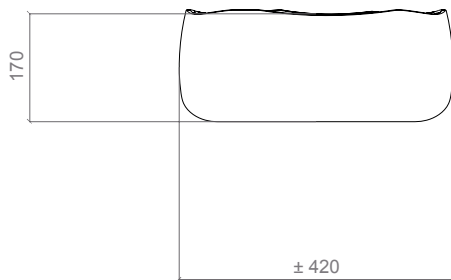

### POSIZIONE RUBINETTERIA E LAVABO TAP AND SINK POSITIONING

TAP AND SINK POSITIONING

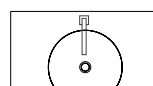
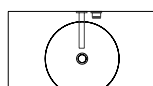
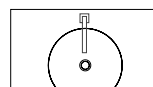
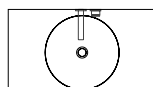
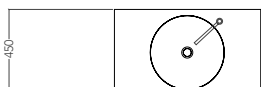
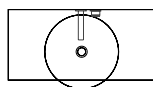
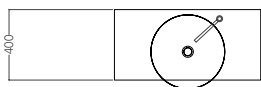

### FORO SUL PIANO DI APPOGGIO HOLE ON THE TOP

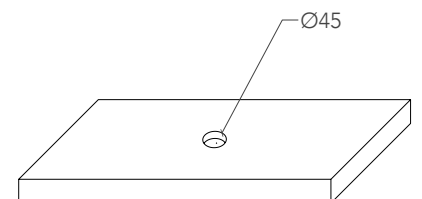

---

**MATERIALE**  
MATERIAL

La terra come fonte di ispirazione per rappresentare colorazioni e sensazioni tattili con finiture bicolore e texture esterne. Terra di Siena è una collezione di lavabi in ceramica realizzati interamente a mano. Lievi differenze cromatiche e imperfezioni di forma sono testimonianza dell'artigianalità del processo produttivo.

*Earth is the source of inspiration for colours and tactile sensations with bi-colour finishes and textural exteriors.*

*The Terra di Siena collection of ceramic washbasin is made entirely by hand. Slight colour differences and shape imperfections are testimony to the craftsmanship of the production process.*

---

**CURA E MANUTENZIONE**  
CARE AND MAINTENANCE

Si prega di pulire l'oggetto soltanto con acqua e sapone neutro, con l'ausilio di panni morbidi.

Non usare per alcun motivo soluzioni contenenti sostanze acide o abrasive e/o aggressive. Una pulizia non corretta potrebbe rovinare permanentemente la superficie; in tal caso l'azienda non potrà essere ritenuta in alcun modo responsabile.

*Please clean the products with water and neutral soap only, using soft towels. Do not use for any reason cleaning solutions containing abrasive or aggressive substances. Incorrect cleaning may permanently ruin the surface of the products and in such case the company may not be held liable for damage.*

---

**ATOSSICITÀ**  
TOXICITY

Il prodotto non risulta tossico o nocivo all'uomo, agli animali e all'ambiente.

*The product does not appear toxic to humans, animals or to the environment.*

---

**RIUTILIZZO**  
REUSE

Non disperdere l'oggetto nell'ambiente. Il prodotto può essere riutilizzato come oggetto decorativo per la casa.

*Do not throw into the environment. The product could be reused as a decorative object for your home.*